

VIKING ***STAGE LIGHTING***

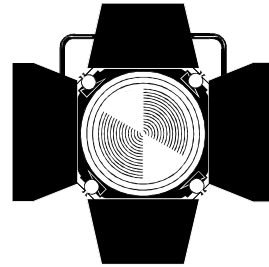

VK740 MK2

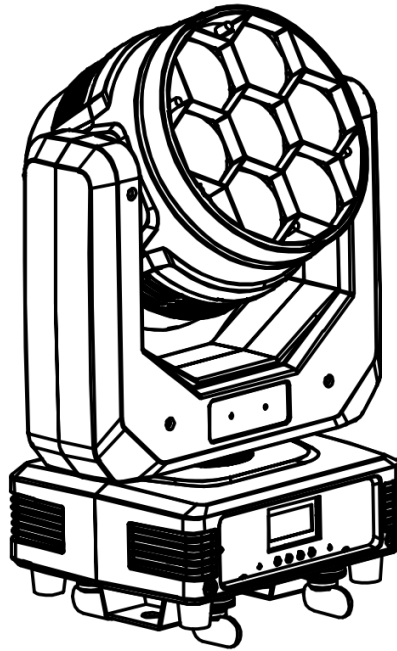

User Manual

TABLE OF CONTENTS

1. Safety Instructions.....	2-4
2. Technical Specifications	3-5
3. How To Control The Unit.....	5-8
4. DMX Channels	8-10
5. shape	10
6. Fixture Cleaning	10

1. Safety Instructions

Please keep this User Guide for future consultation. If you sell the unit to another user, be sure that they also receive this instruction booklet.

- ☒ Unpack and check carefully there is no transportation damage before using the unit.
- ☒ Before operating, ensure that the voltage and frequency of power supply match the power requirements of the unit.
- ☒ It's important to ground the yellow/green conductor to earth in order to avoid electric shock.
- ☒ The unit is for indoor use only. Use only in a dry location.
- ☒ The unit must be installed in a location with adequate ventilation, at least 50cm from adjacent surfaces. Be sure that no ventilation slots are blocked.
- ☒ Disconnect main power before replacement or servicing.

- ☒ Make sure there are no flammable materials close to the unit while operating as it is fire hazard.
- ☒ Use safety cable when rigging this unit. DO NOT handle the unit by taking its head only, but always by taking its base.

- ☒ Maximum ambient temperature is: 40°C. DO NOT operate it where the temperature is higher than this. Unit surface temperature may reach up to 85°C. DO NOT touch the housing bare-hand during its operation. Turn off the power and allow about 15 minutes for the unit to cool down before replacing or serving.

- ☒ In the event of serious operating problem, stop using the unit immediately. Never try to repair the unit by yourself. Repairs carried out by unskilled people can lead to damage or malfunction. Please contact the nearest authorized technical assistance center. Always use the same type spare parts.

- ☒ DO NOT touch any wire during operation as high voltage might be causing electric shock.

Warning:

- ☒ To prevent or reduce the risk of electrical shock or fire, do not expose the unit to rain or moisture.
- ☒ DO NOT open the unit within five minutes after switching off.
- ☒ The housing, the lenses, or the ultraviolet filter must be replaced if they are visibly damaged.

Caution:

There are no user serviceable parts inside the unit. DO NOT open the housing or attempt any repairs yourself. In the unlikely event your unit may require service, please contact your nearest dealer.

Installation:

The unit should be mounted via its screw holes on the bracket. Always ensure that the unit is firmly fixed to avoid vibration and slipping while operating. And make sure that the structure to which you are attaching the unit is secure and is able to support a weight of 10 times of the unit's weight. Also always use a safety cable that can hold 12 times of the weight of the unit when installing the fixture.

The equipment must be fixed by professionals. And it must be fixed at a place where is out of the touch of people.

2. Technical Specifications

Light Sources: 7x 40W 4IN1 RGBW LED

Beam Angle: 4°~ 45°

Power Consumption: 250W

Power Voltage: AC 100-240V, 50/60Hz

Dimension: 25178*334 mm

Net Weight: 5.5 Kgs

Flight case packing (6 in 1): 910x570x550mm

Carton packing (1 in 1):310x230x420mm

Control

DMX Channel: 17 /22CH

Control Modes: DMX512/master-Slave/Auto Run/Music/RDM

Pan/Tilt

Pan/Tilt: 540°/ 270°

Pan/Tilt Resolution: 8/16 bit

Construction

Display: LCD Display

Data In/Out socket: 3-pin XLR sockets

Power Socket: Power con in/out

Protection Rating: IP20

Features

Motorized liner zoom system

Outstanding color macro effect

Dimmer: 0~100% smooth dimming

Variable strobe effects

Fast, quiet operation and flicker free

3. LUX Data:

Min Zoom range = 4°

R lux	21900	4930	1950	797
G lux	54900	14000	5260	2120
B lux	10700	2700	993	397
W lux	64000	16000	6110	2480
4in1 lux	138000	34200	12900	5250

Max Zoom range = 45°

R lux	3000	382	140	63
G lux	7580	902	360	143
B lux	1450	167	67	27
W lux	8850	112	426	164
4in1 lux	19000	2100	862	348

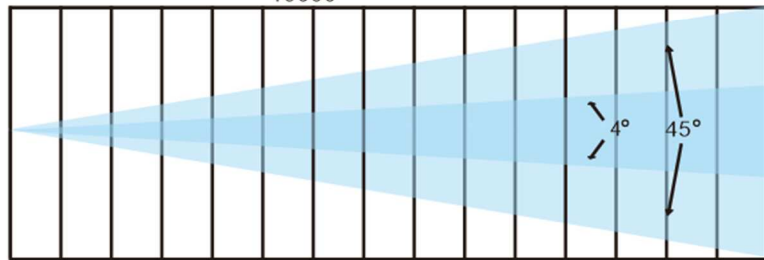

Distance (m)	1	3	5	8
Spot diameter (m) 4°	0.30	0.65	1.00	1.50
Spot diameter (m) 45°	0.86	2.00	3.50	

4. How To Control The Unit:

DMX512 is widely used in intelligent lighting control, with a DMX 512 controller you can connect several lights together via dmx in and dmx out sockets to form a ring.

3 pin XLR connectors:

Pin 1: GND, Pin 2: Negative signal (-), Pin 3: Positive signal (+)

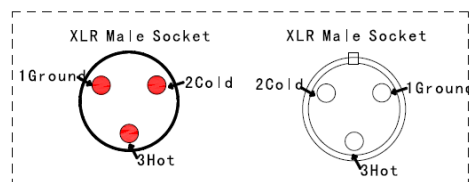
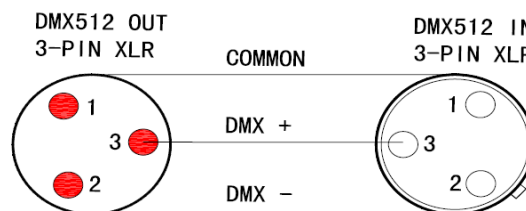
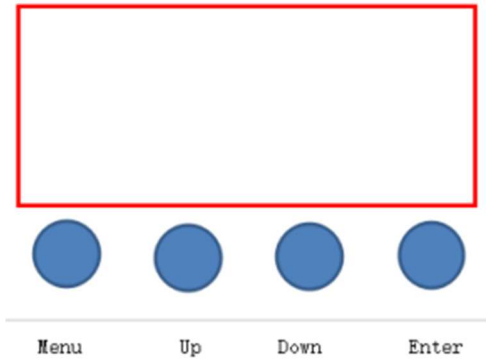

Figure2

XLR Pin Configuration
pin1=Ground
pin2=Data Compliment (negative)
pin3=Data true (positive)

Display:



MENU To select the programming functions
 DOWN To go backward in the selected functions

UP To go forward in the selected functions
 ENTER To confirm the selected functions

Set DMX Address:

- 1) Press “Menu” to set DMX Address, and press “ENTER”
- 2) LCD Display will show show “SET DMX Address:001”
- 3) Press “Up” or “Down” to adjust the DMX address number and press “Enter” to save value

LCD Display Menu Options:

1	Address	Address 001~512	Address setting 001-512
2	Mode	1.DMX512	Console control
		2.Auto	1.Master
			2.Alone
		3.Sound	1.Master
			2.Alone
		4.Manual	1.Pan:0-255
			2.Tilt:0-255
			3.Focus:0-255
			4.Red:0-255
			5.Green:0-255
6.Blue:0-255			
3	Channel	1.17CH	
		2.22CH	

4	Invert	1.Pan Invert	1.NO,2.YES
		2.Tilt Invert	1.NO,2.YES
5	Sound	0-100	Sound sensitivity
6	Degree	1.540, 2.360	
7	No signal	1.black out	2.hold
8	Fan set	1.auto, 2.high, 3.low	
9	Reset	1.NO	Reset
		2.YES	
10	Default	3.Yes	Factory setting
		4.No	
11	Inform	1.Soft V1.0	Show the version number
		2.Temp /°C	Show the temperature of led board
12	Adjust	Pass word	****
		1.Pan	0-255Pan fine control
		2.Tilt	0-255Tilt fine control
		3.Focus	0-255 Zoom fine control
		4.Red	0-255
		5.Green	0-255
		6.Blue	0-255
		7.White	0-255

5. DMX Channels:

DMX channel's functions and values)

17 channel mode:

Channel	Function	Description	Value
Ch 1	pan adjustment	pan adjustment	0---255
Ch 2	Pan fine adjustment	Pan fine adjustment	0---255
Ch 3	Tilt adjustment	Tilt adjustment	0---255
Ch 4	Tilt fine adjustment	Tilt fine adjustment	0---255
Ch 5	Speed of Pan/Tilt	from fast to slow	0---255
Ch 6	Strobe	Turn on the light	0---3
		Synchro strobe speed slow to fast (1HZ-25HZ)	4---203
		Random strobe	204---255
Ch 7	Dimmer	from dark to bright	0---255
Ch 8	Dimming mode	mode 1	0---49

		mode 2	50----99
		mode 3	100----149
		mode 4	150----255
Ch 9	Zoom	From near to far	0----255
Ch 10	R	from dark to bright	0----255
Ch 11	G	from dark to bright	0----255
Ch 12	B	from dark to bright	0----255
Ch 13	W	from dark to bright	0----255
Ch 14	Static color	No function	0----15
		R100%, G up,B0%	16----35
		R down,G100%,B0%	36---55
		R0%,G100%,B up	56---75
		R0%,G down,B100%	76---95
		R up,G0%,B100%	96---115
		R100%,G up,B down	116---135
		R 100%down,G Up,B Up	136--155
		R down,G down,B100%	156---175
		R100%,G100%,B100%,W 100%	176--195
		2800K	196--200
		3200K	201--205
		4000K	206--210
		4500K	211-215
		5000K	216-220
		5600K	221-225
		6500K	226-230
7000K	231-235		
7500K	236-240		
8000K	241-255		
Ch 15	Moving color	No function	0----49
		Skip change	50----99
		Gradual change	100----255
Ch 16	Speed of Moving color	from fast to slow	0----255
Ch 17	Reset	no function	0----79
		Reset 5s	80----99
		No function	100----255

22 Channel Mode:

22 Channel Mode includes 16bit fine adjustments plus 4 different dimming modes of the Dimmer.

Channel	Function	Description	Value
Ch 1	pan adjustment	pan adjustment	0---255
Ch 2	Pan fine adjustment	Pan fine adjustment	0---255
Ch 3	Tilt adjustment	Tilt adjustment	0---255
Ch 4	Pan fine adjustment	Pan fine adjustment	0---255
Ch 5	Speed of Pan/Tilt	from fast to slow	0---255
Ch 6	Zoom	From near to far	0---255
Ch 7	Dimmer	from dark to bright	0---255
Ch 8	Dimming fine adjustment	Dimming adjustment control	0---255
Ch 9	Strobe	No function	0---3
		strobe speed slow to fast (1HZ-25HZ)	4---203
		Random strobe	204---255
Ch 10	R	from dark to bright	0---255
Ch 11	Red fine adjustment	Red fine adjustment	0---255
Ch 12	G	from dark to bright	0---255
Ch 13	Green fine adjustment	Green fine adjustment	0---255
Ch 14	B	from dark to bright	0---255
Ch 15	Blue fine adjustment	Blue fine adjustment	0---255
Ch 16	W	from dark to bright	0---255
Ch 17	White fine adjustment	White fine adjustment	0---255
Ch 18	Dimming mode	mode 1	0---49
		mode 2	50---99
		mode 3	100---149
		mode 4	150---255

Channel	Function	Description	Value
Ch 19	Static color	No function	0----15
		R100%, G up,B0%	16----35
		R down,G100%,B0%	36----55
		R0%,G100%,B up	56----75
		R0%,G down,B100%	76----95
		R up,G0%,B100%	96----115
		R100%,G up,B down	116---135
		R 100%down,G Up,B Up	136---155
		R down,G down,B100%	156---175
		R100%,G100%,B100%, W100%	176---195
		2800K	196---200
		3200K	201---205
		4000K	206---210
		4500K	211---215
		5000K	216---220
		5600K	221---225
		6500K	226---230
		7000K	231---235
		7500K	236---240
8000K	241---255		
Ch 20	Moving color	No function	0----49
		Skip change	50----99
		Gradual change	100---255
Ch 21	Speed of Moving color	from fast to slow	0---255
Ch 22	Reset	no function	0---79
		Reset 5s	80---99
		No function	100---255

6. Shape

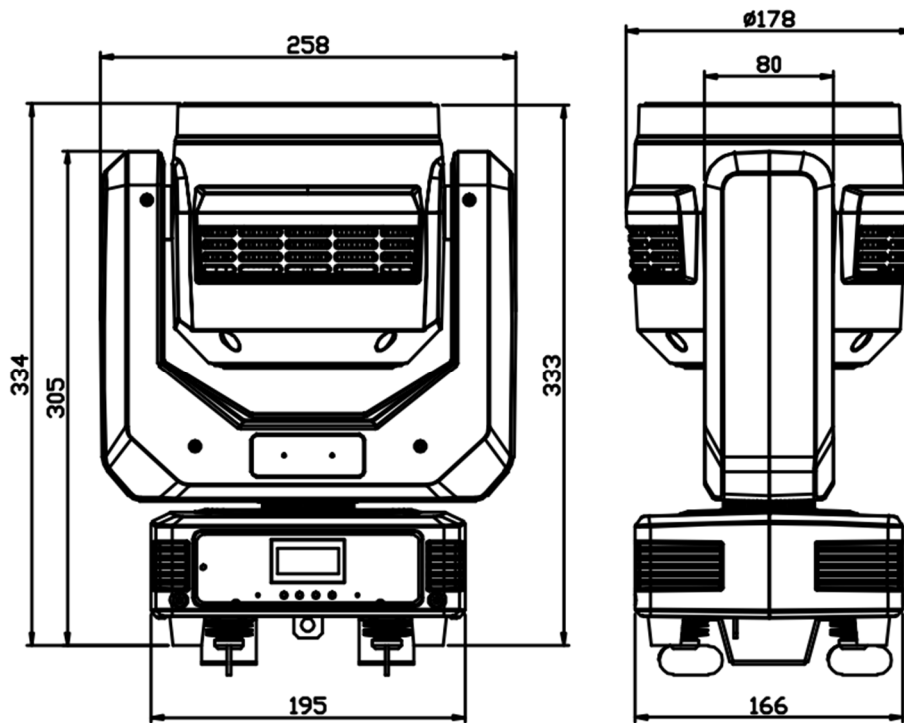

1. DMX LED should be on. If not, check DMX connectors, cables to see if link properly.
2. If the DMX LED is on and no response to the channel, check the address settings and DMX polarity.
3. If you have intermittent DMX signal problems, check the pins on connectors or on

8. Fixture Cleaning

The cleaning of internal and external optical lenses and/or mirrors must be carried out periodically to optimize light output. Cleaning frequency depends on the environment in which the fixture operates: damp, smoky or particularly dirty surrounding can cause greater accumulation of dirt on the unit's optics.

- **Clean with soft cloth using normal glass cleaning fluid.**
- **Always dry the parts carefully.**
- **Clean the external optics at least every 20 days. Clean the internal optics at least every 30/60 days.**